

GHOST PARETE

ISTRUZIONI DI MONTAGGIO ASSEMBLY INSTRUCTIONS

MODELLI
MODELS:

- 411/78.2000.22 Ghost parete 880
Ghost wall 880
- 411/78.2001.22 Ghost parete 980
Ghost wall 980
- 411/78.2002.22 Ghost parete 1080
Ghost wall 1080



CONTENUTO DELLA CONFEZIONE INCLUDED IN THE PACKAGING

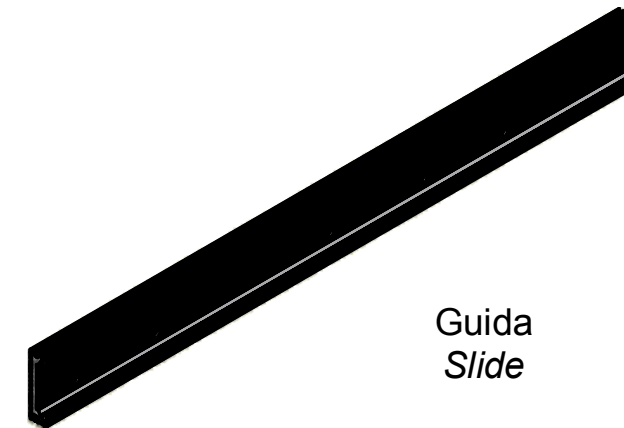

Guida
Slide

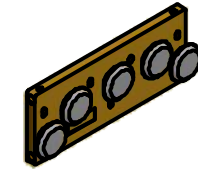

Piastra
Plate

SACCHETTO ACCESSORI - ACCESSORIES

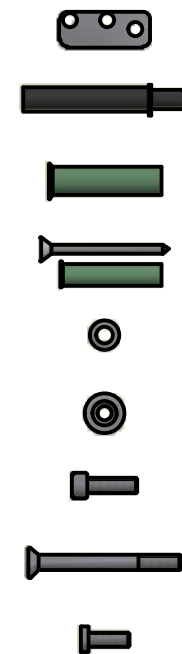

- A. Piatto guida porta - *Guide plate (x 1)*
- B. Piastra ghost muro - *Wall plate (x 1)*
- C. Fine corsa - *Limit switch (x 2)*
- D. Blumotion - *Blumotion (x 2)*
- E. Tassello M6x45 Ø10 - *Dowel M6x45 Ø10 (x 4)*
- F. Tassello Ø8 + Vite TPS M6 - *Dowel Ø10 + M6 screw (x 6)*
- G. Rondella mm 12x2 Ø6.3 - *Washer 12x2 mm Ø6.3 (x 7)*
- H. Rondella conica mm Ø16x7 - *Conical washer mm Ø16x7 (x 6)*
- I. Vite TCCE M6x20 - *Socked head cap screws M6x20 (x 7)*
- J. Vite TPS M6x60 CE - *Screw M6x60 TPS CE (x 4)*
- K. Vite TC trilobata M5x16 croce - *M5x16 TC Phillips trilobate screw (x 4)*
- L. Tappi - *Caps (x 2)*

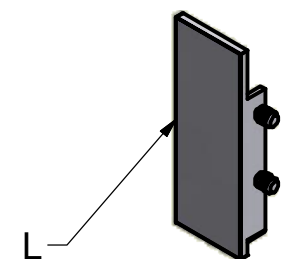
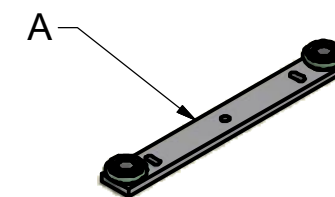
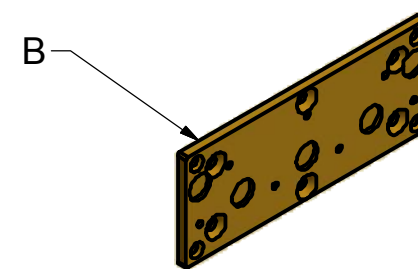

DIMENSIONI GENERALI GENERAL DIMENSIONS

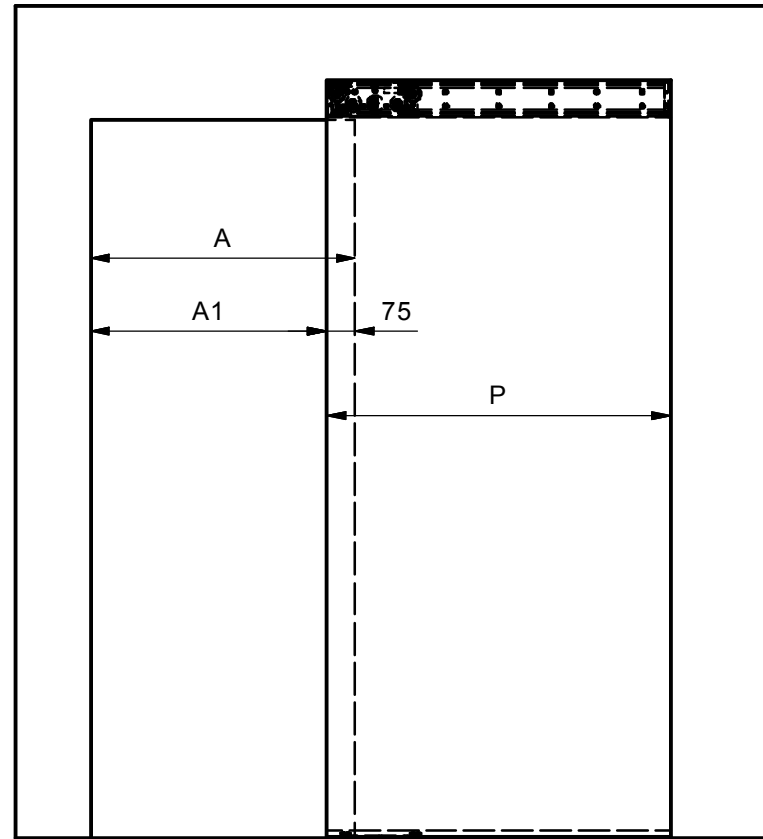

APERTO
OPEN

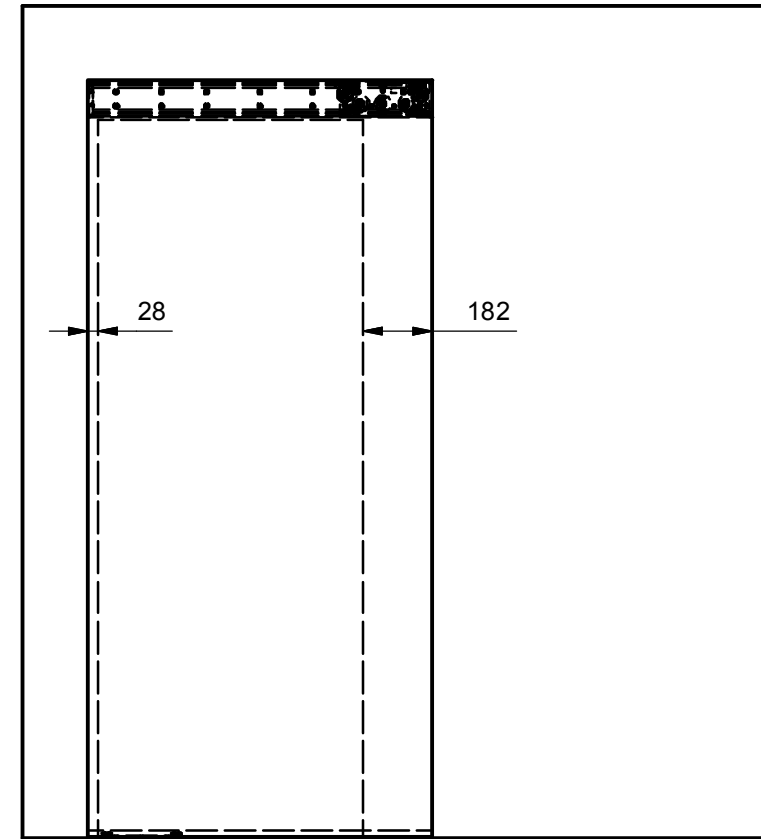

CHIUSO
CLOSE

DIMENSIONE - DIMENSION	SIMBOLO - SYMBOL	411/78.2000.22	411/78.2001.22	411/78.2002.22
LARGHEZZA LUCE NETTA - OPENING WIDTH	A	700	800	900
LUCE NETTA PASSAGGIO - NET OPENING	A1	625	725	825
LARGHEZZA PORTA - DOOR WIDTH	P	910	1010	1110

DIMENSIONI PORTA

SIZE DOOR

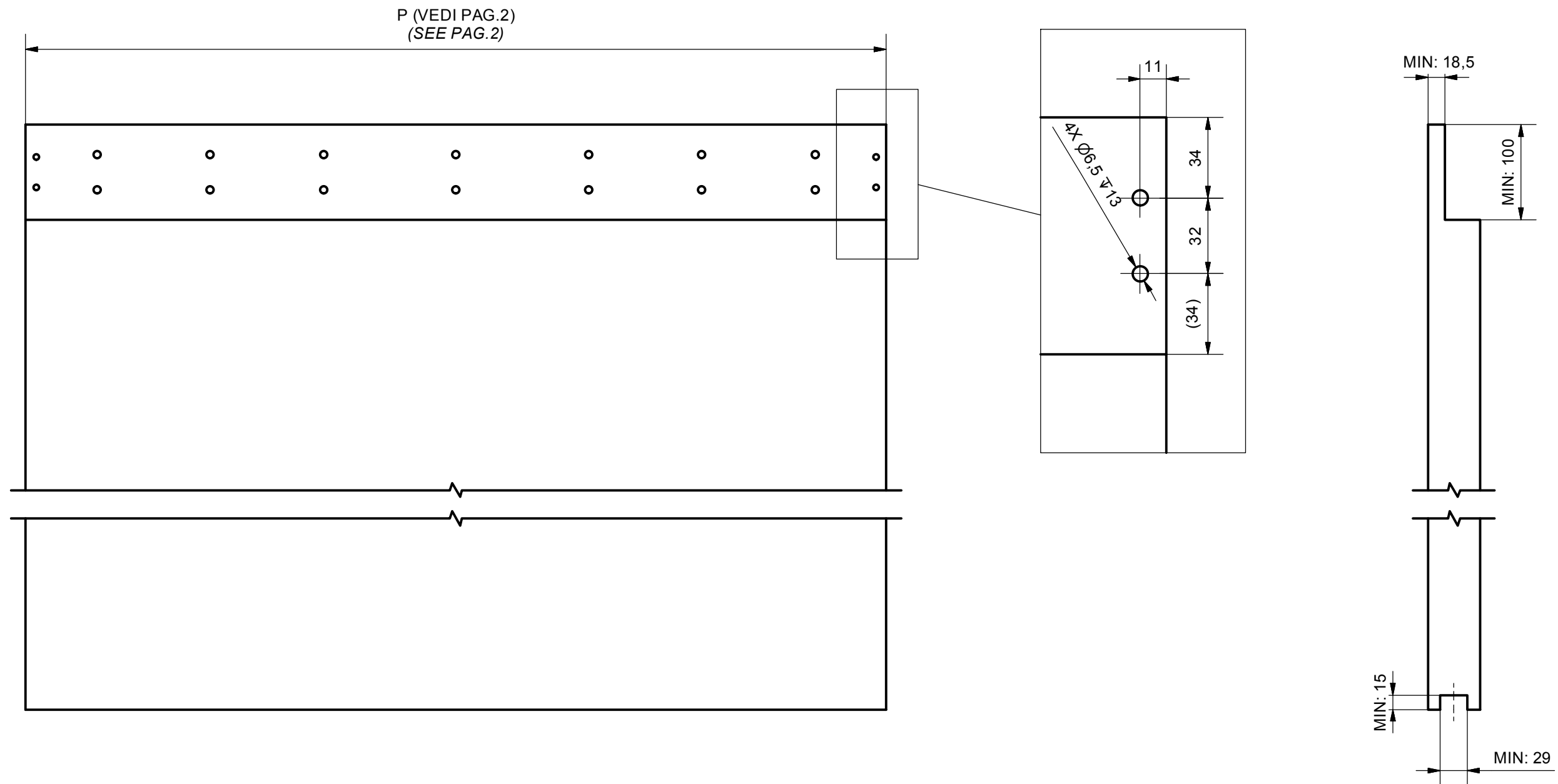

POSIZIONE FORI FISSAGGIO GUIDA - PORTA (CONSIGLIATO) **POSITION HOLES FIXING GUIDE - DOOR (RECOMMENDED)**

FORI FISSAGGIO GUIDA - PORTA Ø8 ∇13 PER BUSSOLE M6 (BUSSOLE E VITI NON INCLUSE)
FIXING HOLES GUIDE - DOOR. BUSH Ø8 x13 M6 (BUSHES AND SCREWS NOT INCLUDED)

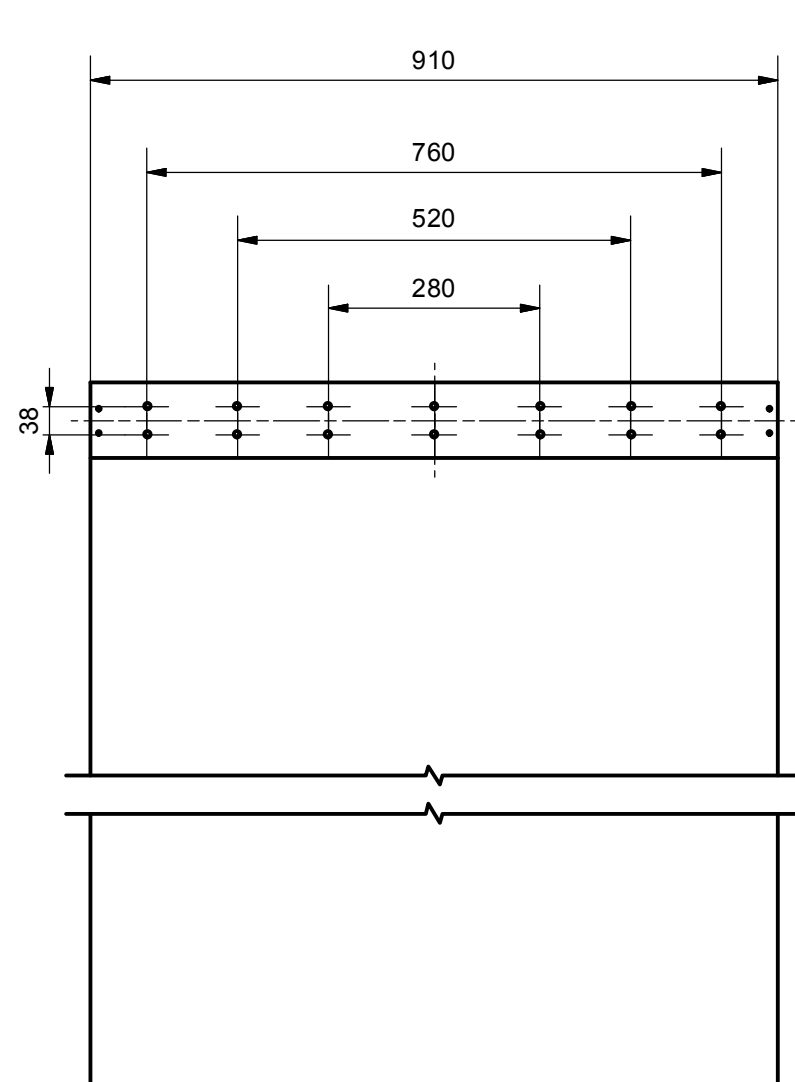

411/78.2000.22

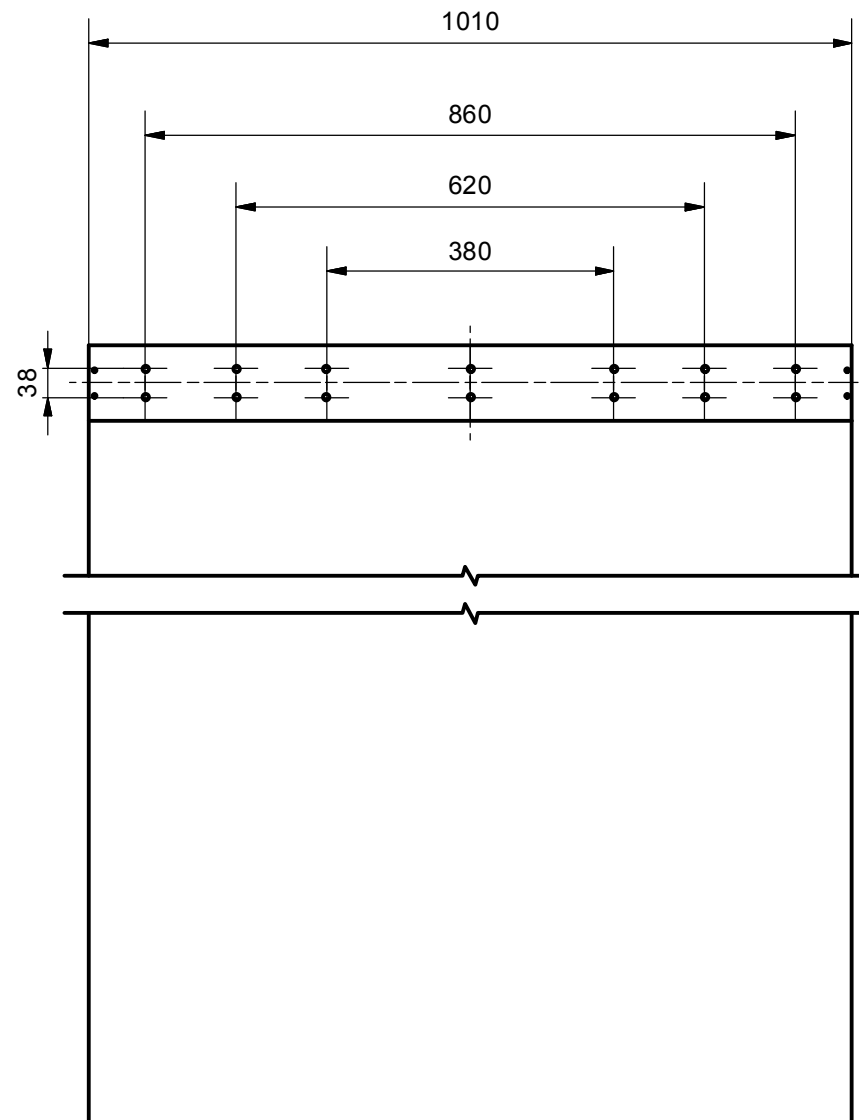

411/78.2001.22

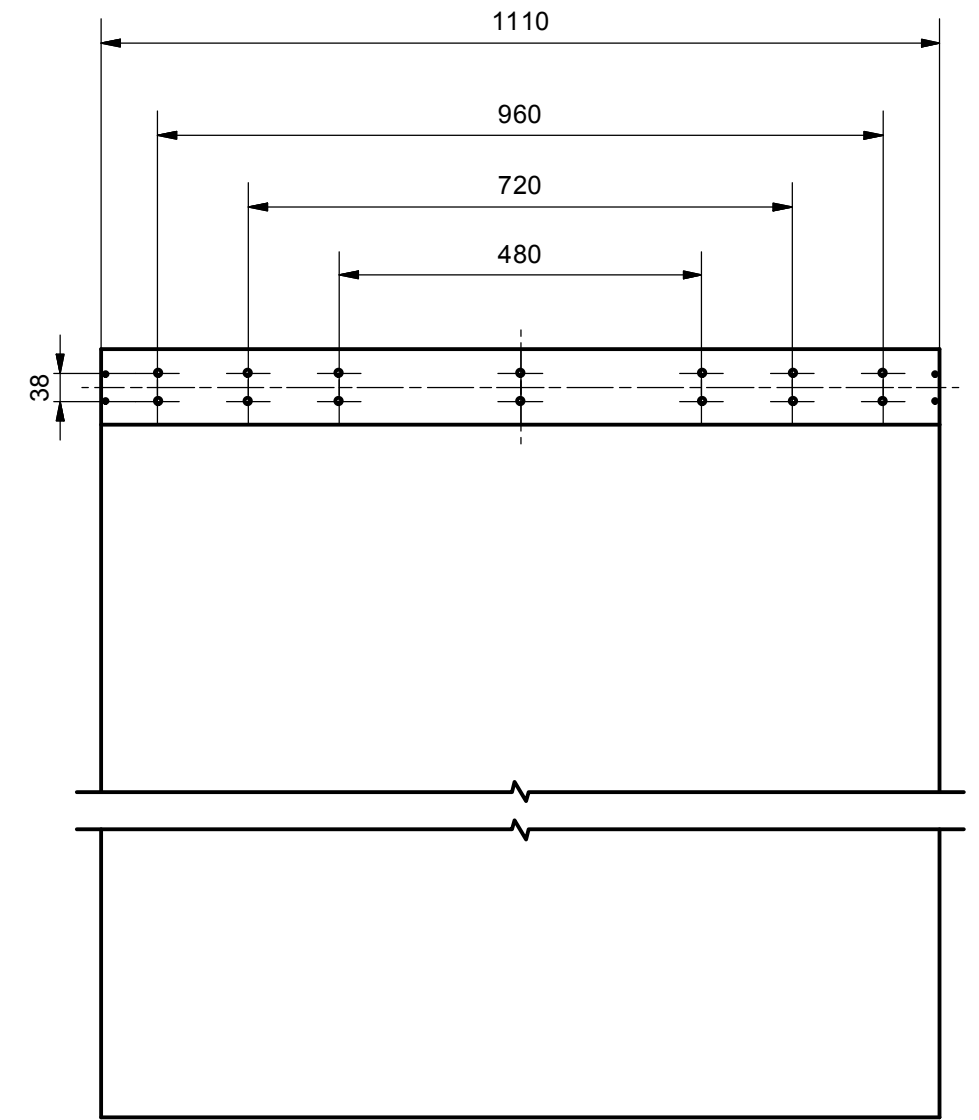

411/78.2002.22

POSIZIONE FORI AL MURO

POSITION HOLES ON THE WALL

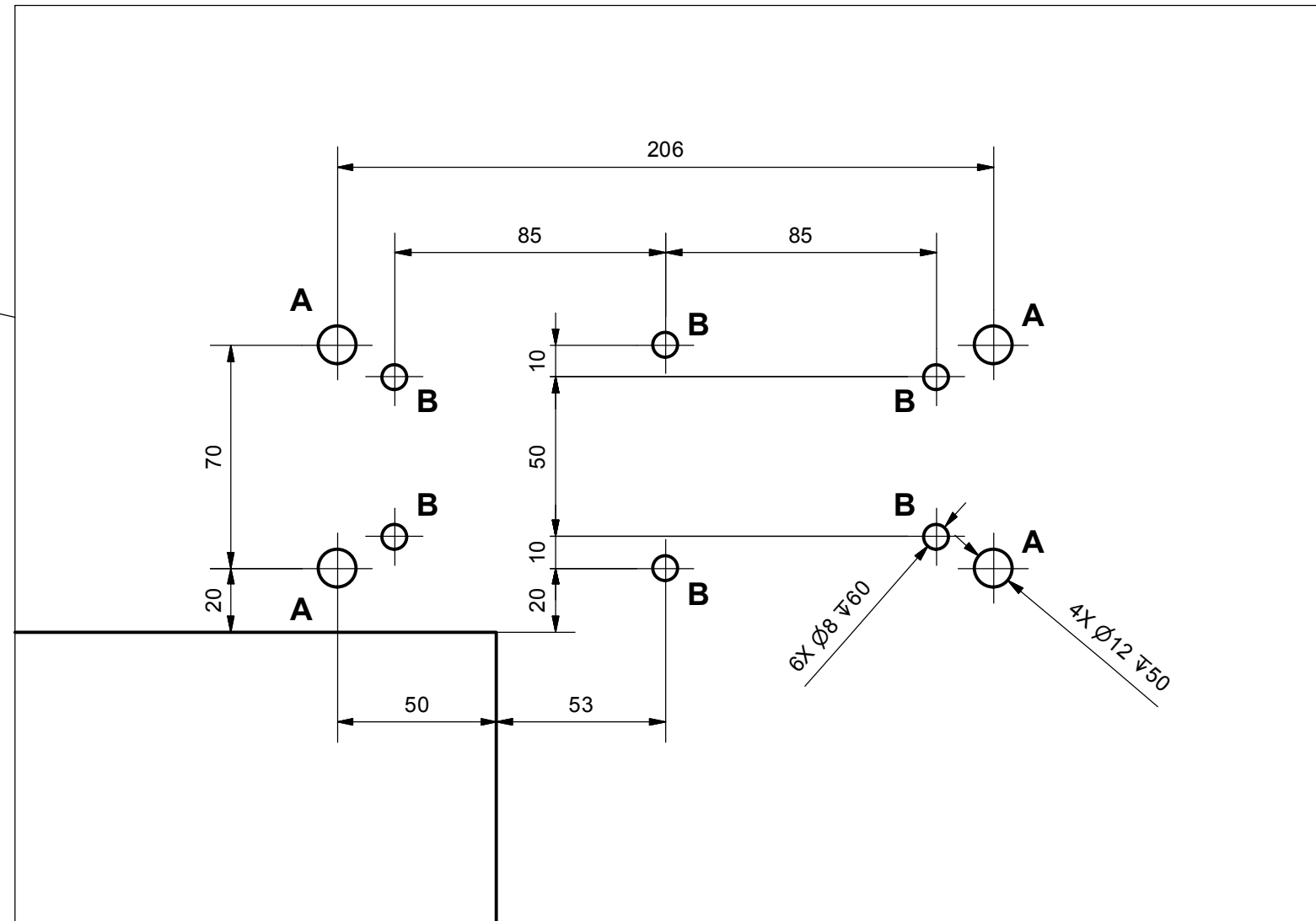
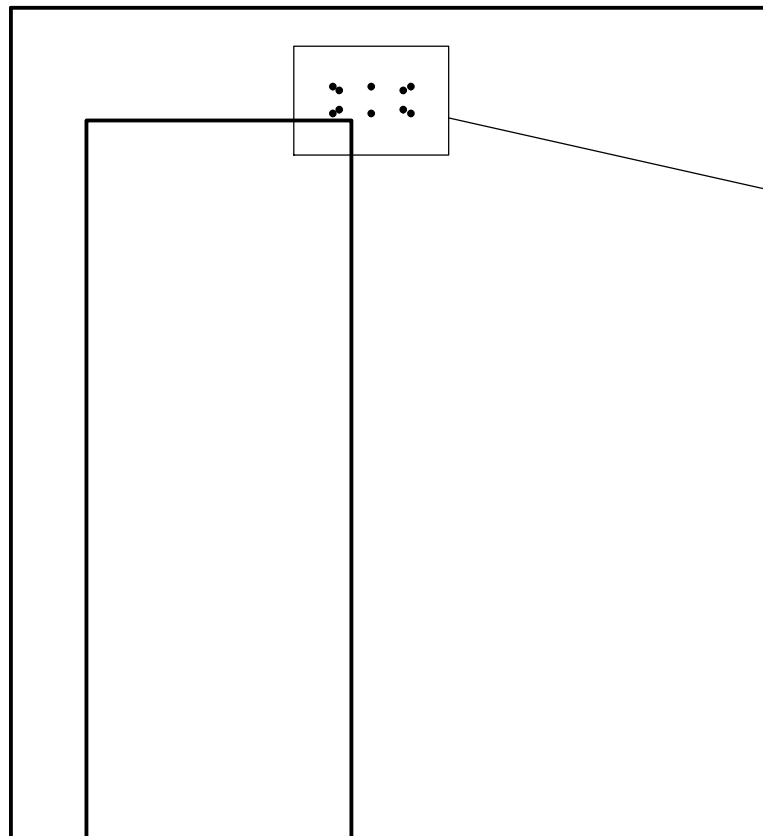

ESEGUIRE I FORI "A", POI FISSARE LA PIASTRA CON I 4 TASSELLI "E" E USARLA
COME DIMA PER ESEGUIRE I FORI "B" USATI PER FISSAGGIO CON I SEI TASSELLI F.
DRILL FIRST THE FOUR "A" HOLES AND FIX THE PLATE WITH THE FOUR "E" DOWELS,
THEN USE THE PLATE AS A DIME FOR DRILLING THE SIX "B" HOLES TO BE USED
WITH THE SIX "F" DOWELS.

POSIZIONE PIASTRA A TERRA

POSITION PLATE GROUND

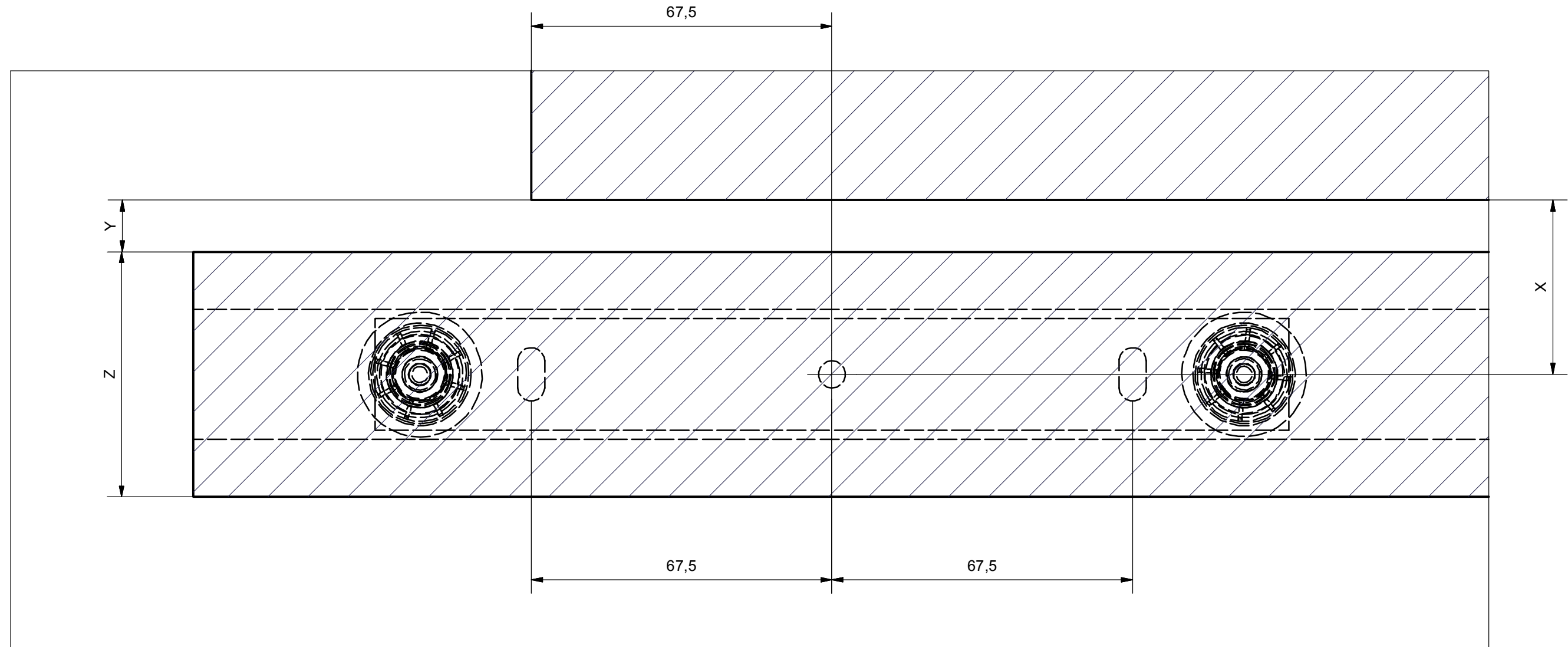







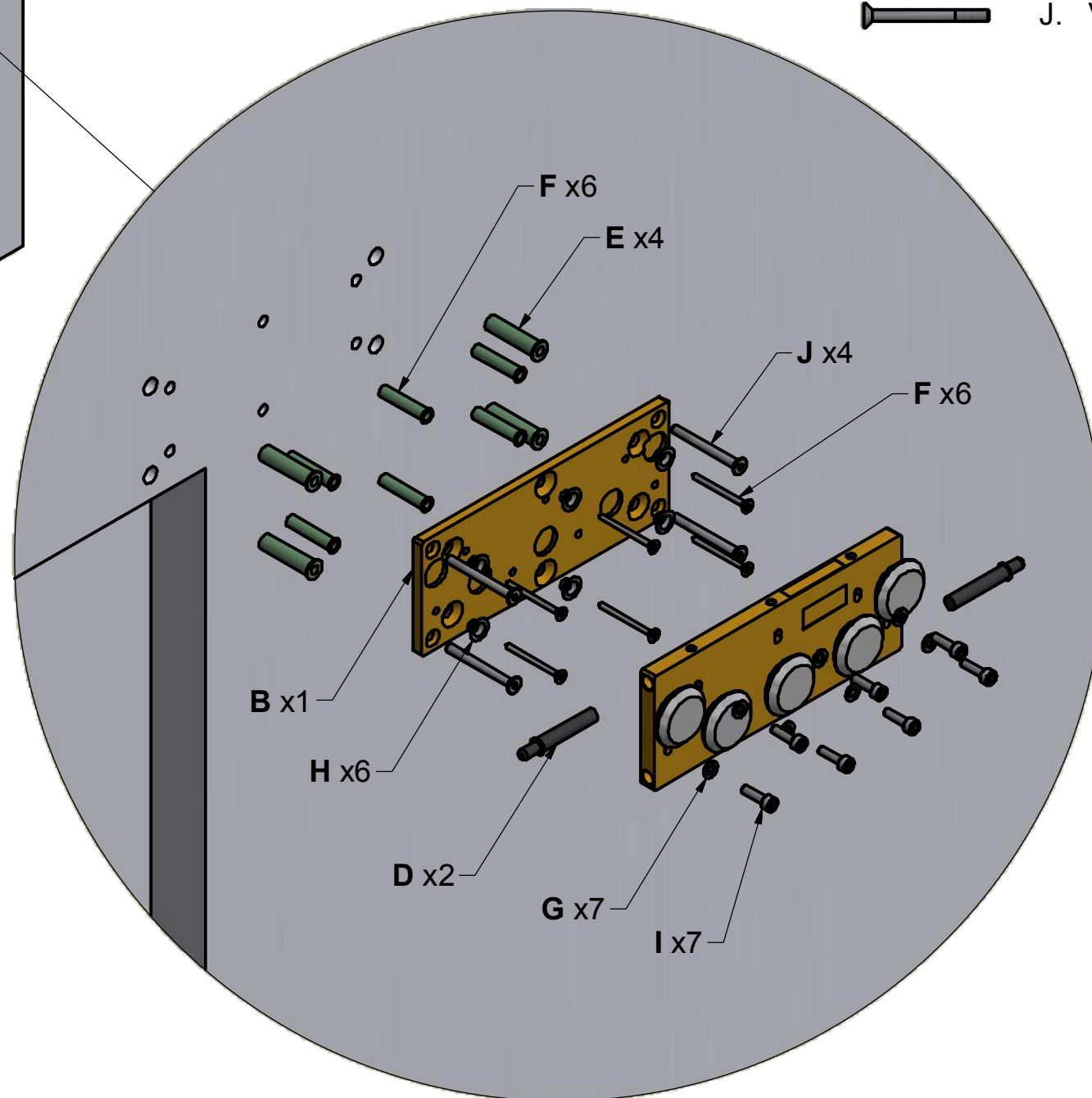
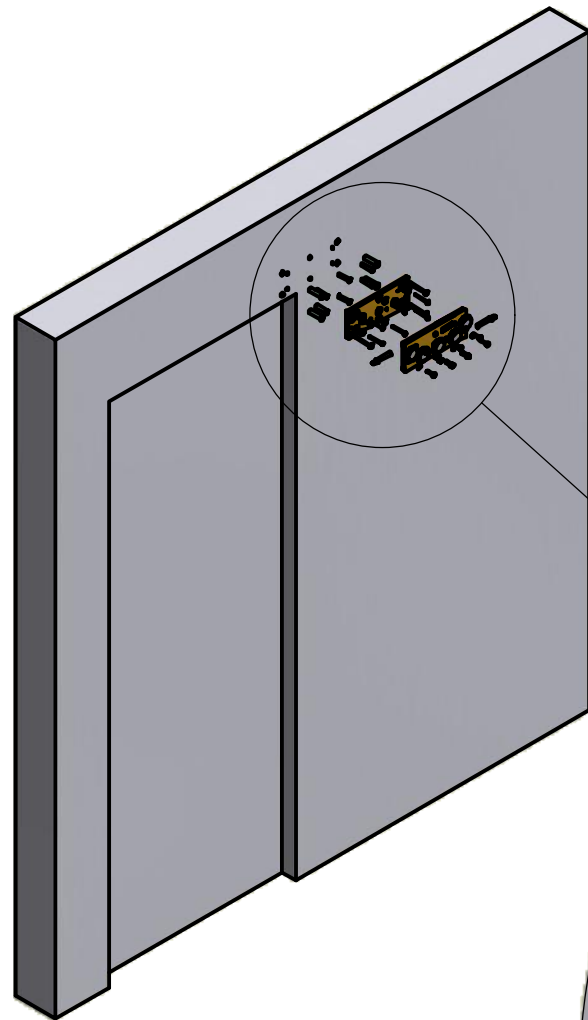

Z (mm)	X (mm)	Y (mm)
40	46.5	26.5
45	44	21.5
50	41.5	16.5
55	39	11.5
60	36.5	6.5

MONTAGGIO DEL MECCANISMO

MOUNTING OF THE MECHANISM

SACCHETTO ACCESSORI - ACCESSORIES



-  D. Blumotion - *Blumotion* (x2)
-  E. Tassello M6x45 Ø10 - *Dowel M6x45 Ø10* (x 4)
-  F. Tassello Ø8 + Vite TPS M6 - *Dowel Ø10 + M6 screw* (x 6)
-  G. Rondella mm 12x2 Ø6.3 - *Washer 12x2 mm Ø6.3* (x 7)
-  H. Rondella conica mm Ø16x7 - *Conical washer mm Ø16x7* (x 6)
-  I. Vite TCCE M6x20 - *Socketed head cap screws M6x20* (x 7)
-  J. Vite TPS M6x60 CE - *Screw M6x60 TPS CE* (x 4)

REGOLAZIONE DEL MECCANISMO REGULATION OF THE MECHANISM

