

Easy to implement – convenient to use.

Hardware system for pivot sliding cabinet doors weighing up to 25, 30, 40 and 50 kg (55/66/88/110 lbs.)

Description

The Hawa Concepta 25/30/40/50 slides doors alongside cabinet bodies or into wall recesses. Room-high designs and walk-in cabinets are easy and efficient to implement. The well-thought-out concept has omitted a bottom guide channel and offers optimum flexible room utilisation with no obstructions in the form of protruding doors. Hawa Concepta 25/30/40/50 is a true master of design thanks to a broad band width of available dimensions, weights and material thicknesses, and the combinations which are possible with Hawa Folding Concepta 25.

Application

Its advantages are obvious wherever variable room utilisation and unobstructed access should leave a tidy impression, for instance the home office in the bedroom, or to hide appliances in the kitchen or the washing machine in the bathroom. Even walk-in cabinets are realizable. For an optimum closing movement, it is advisable not to drop below the minimum door weight.

Features of Hawa Concepta 25

- Door weight 10 (22 lbs.) to 25 kg (55 lbs.)
→ door weight/height ratio
- Door width 300–750 mm ($11\frac{13}{16}$ "– $2'5\frac{17}{32}$ ")
- Door height 1250–1850 mm ($4'1\frac{7}{16}$ "– $6'0\frac{27}{32}$ ")
- Door thickness 19–50 mm ($\frac{3}{4}$ "– $1\frac{31}{32}$ ")

Features of Hawa Concepta 30

- Door weight 15 (33 lbs.) to 30 kg (66 lbs.)
→ door weight/height ratio
- Door width 300–900 mm ($11\frac{13}{16}$ "– $2'11\frac{7}{16}$ ")
- Door height 1851–2300 mm ($6'0\frac{7}{8}$ "– $7'6\frac{9}{16}$ ")
- Door thickness 19–50 mm ($\frac{3}{4}$ "– $1\frac{31}{32}$ ")

Features of Hawa Concepta 40

- Door weight 20 (44 lbs.) to 40 kg (88 lbs.)
→ door weight/height ratio
- Door width 300–900 mm ($11\frac{13}{16}$ "– $2'11\frac{7}{16}$ ")
- Door height 1851–2500 mm ($6'0\frac{7}{8}$ "– $8'2\frac{7}{16}$ ")
- Door thickness 19–50 mm ($\frac{3}{4}$ "– $1\frac{31}{32}$ ")

Features of Hawa Concepta 50

- Door weight 25 (55 lbs.) to 50 kg (110 lbs.)
→ door weight/height ratio
- Door width 300–900 mm ($11\frac{13}{16}$ "– $2'11\frac{7}{16}$ ")
- Door height 2301–2850 mm ($7'6\frac{19}{32}$ "– $9'4\frac{7}{32}$ ")
- Door thickness 19–50 mm ($\frac{3}{4}$ "– $1\frac{31}{32}$ ")

Features of Hawa Concepta 25/30/40/50

- Hawa Concepta 25/30 with guide rollers, top and bottom
- Hawa Concepta 40/50 with two-wheeled trolley, top
- Concealed hinge with soft closing mechanism
- Door is automatically pulled into pocket
- Well thought-out shock absorber in the end positions provides a high degree of movement comfort
- Unique scissor technology accommodates large and heavy doors
- All adjustments are made from the front
- All components are screwed onto the intermediate panel
- Wall recesses can be concealed without a cabinet body
- The same set can be used for left and right hand side applications
- The connector profile makes it easier to assemble cabinet designs with doors striking against the top and bottom cabinet sections
- Certified LGA

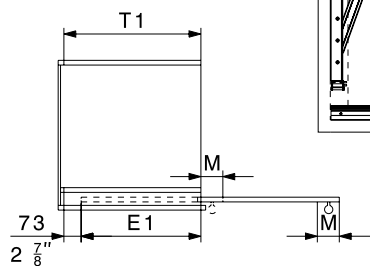
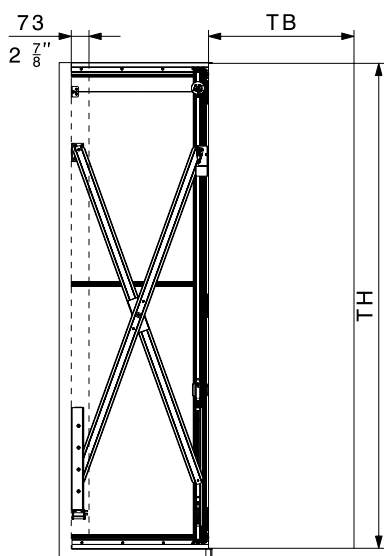
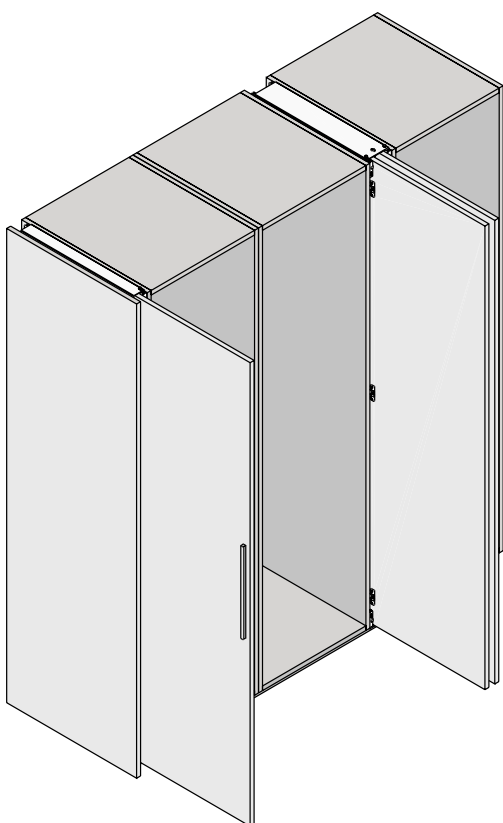

$$T1 = TB - M + 73 \text{ mm } (2\frac{7}{8}'')$$

$$E1 = T1 - 73 \text{ mm } (2\frac{7}{8}'')$$

Calculation hardware depth

	T1	TH	E1
Hawa Concepta 25	≤ 650 mm (2'1 $\frac{31}{32}$ ")	1250–1850 mm (4'1 $\frac{7}{16}$ "–6'0 $\frac{27}{32}$ ")	≤ 577 mm (1'10 $\frac{23}{32}$ ")
Hawa Concepta 30	≤ 900 mm (2'11 $\frac{7}{16}$ ")	1851–2300 mm (6'0 $\frac{7}{8}$ "–7'6 $\frac{9}{16}$ ")	≤ 827 mm (2'8 $\frac{9}{16}$ ")
Hawa Concepta 40	≤ 900 mm (2'11 $\frac{7}{16}$ ")	1851–2500 mm (6'0 $\frac{7}{8}$ "–8'2 $\frac{7}{16}$ ")	≤ 827 mm (2'8 $\frac{9}{16}$ ")
Hawa Concepta 50	≤ 900 mm (2'11 $\frac{7}{16}$ ")	2301–2850 mm (7'6 $\frac{19}{32}$ "–9'4 $\frac{7}{32}$ ")	≤ 827 mm (2'8 $\frac{9}{16}$ ")

Use our planning tool:
www.concepta.hawa.com

Subject to modification. Metric specifications are exact. Inches are approximate.

Sets, Hawa Concepta 25/30

	mm/inch	code
Hawa Concepta 25, set for 1 door	1250 – 1850 (4'1 ⁷ / ₁₆ " – 6'0 ²⁷ / ₃₂ ")	27648
Hawa Concepta 30, set for 1 door	1851 – 2300 (6'0 ⁷ / ₈ " – 7'6 ⁹ / ₁₆ ")	27649
Sets contents: → page 24		

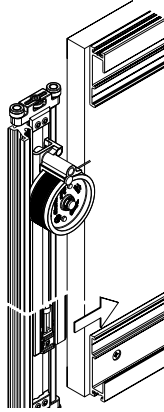

Hawa Concepta 25/30

Sets, Hawa Concepta 40/50

	mm/inch	code
Hawa Concepta 40, set for 1 door	1851 – 2500 (6'0 ⁷ / ₈ " – 8'2 ⁷ / ₁₆ ")	27650
Hawa Concepta 50, set for 1 door	2301 – 2850 (7'6 ¹⁹ / ₃₂ " – 9'4 ⁷ / ₃₂ ")	27651
Sets contents: → page 25		

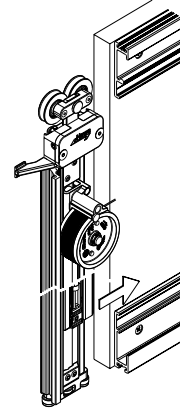

Hawa Concepta 40/50

Door weight / height ratio

The maximum weight must be adjusted in accordance with the size of the doors.

Hawa Concepta 25

TB TH	300	350	400	450	500	550	600	650	700	750
1850	25	25	25	25	25	25	25	24	23	22
1800	25	25	25	25	25	25	25	23	22	21
1750	25	25	25	25	25	25	24	22	21	21
1700	25	25	25	25	25	25	24	21	21	20
1650	25	25	25	25	25	25	23	21	20	19
1600	25	25	25	25	25	24	22	20	19	18
1550	25	25	25	25	25	24	21	19	18	18
1500	25	25	25	25	25	23	21	18	18	17
1450	25	25	25	25	24	22	20	18	17	16
1400	25	25	25	25	24	21	19	17	16	15
1350	25	25	25	24	23	21	18	16	16	15
1300	25	25	25	24	22	20	18	15	15	14
1250	25	25	24	23	21	19	17	15	14	13
Door weight in kg / TB = Door width in mm / TH = Door height in mm										

Hawa Concepta 40

TB TH	300	350	400	450	500	550	600	650	700	750	800	850	900
2500	40	40	40	40	40	40	40	40	40	37	34	32	31
2450	40	40	40	40	40	40	40	40	39	36	34	32	30
2400	40	40	40	40	40	40	40	40	38	35	33	31	29
2350	40	40	40	40	40	40	40	40	37	34	32	30	29
2300	40	40	40	40	40	40	40	39	36	33	31	30	28
2250	40	40	40	40	40	40	40	38	35	33	31	29	27
2200	40	40	40	40	40	40	40	37	34	32	30	28	27
2150	40	40	40	40	40	40	39	36	33	31	29	27	26
2100	40	40	40	40	40	40	38	35	32	31	28	27	25
2050	40	40	40	40	40	40	37	34	31	30	28	26	24
2000	40	40	40	40	40	39	36	33	31	29	27	25	24
1950	40	40	40	40	40	38	35	32	30	28	26	24	23
1900	40	40	40	40	40	37	34	31	29	27	25	24	22
1851	40	40	40	40	39	36	33	30	28	26	24	23	22
Door weight in kg / TB = Door width in mm / TH = Door height in mm													

Hawa Concepta 30

TB TH	300	350	400	450	500	550	600	650	700	750	800	850	900
2300	30	30	30	30	30	30	30	30	30	30	29	27	26
2250	30	30	30	30	30	30	30	30	30	30	28	27	25
2200	30	30	30	30	30	30	30	30	30	29	27	26	24
2150	30	30	30	30	30	30	30	30	30	29	27	25	24
2100	30	30	30	30	30	30	30	30	30	28	26	25	23
2050	30	30	30	30	30	30	30	30	29	27	25	24	23
2000	30	30	30	30	30	30	30	30	29	26	25	23	22
1950	30	30	30	30	30	30	30	29	27	26	24	23	21
1900	30	30	30	30	30	30	30	29	27	25	23	22	21
1851	30	30	30	30	30	30	30	28	26	24	23	21	20
Door weight in kg / TB = Door width in mm / TH = Door height in mm													

Hawa Concepta 50









TB TH	300	350	400	450	500	550	600	650	700	750	800	850	900
2850	50	50	50	50	50	50	50	50	50	50	50	50	50
2800	50	50	50	50	50	50	50	50	50	50	50	50	50
2750	50	50	50	50	50	50	50	50	50	50	50	50	50
2700	50	50	50	50	50	50	50	50	50	50	50	50	49
2650	50	50	50	50	50	50	50	50	50	50	50	50	48
2600	50	50	50	50	50	50	50	50	50	50	50	49	48
2550	50	50	50	50	50	50	50	50	50	50	50	48	47
2500	50	50	50	50	50	50	50	50	50	50	49	48	46
2450	50	50	50	50	50	50	50	50	50	49	48	47	45
2400	50	50	50	50	50	50	50	50	50	48	48	46	45
2350	50	50	50	50	50	50	50	50	49	48	47	45	44
2301	50	50	50	50	50	50	50	49	48	47	46	45	43
Door weight in kg / TB = Door width in mm / TH = Door height in mm													

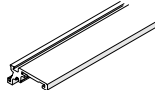

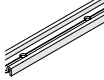

Subject to modification. Metric specifications are exact. Inches are approximate.

Sets, Hawa Concepta 25/30

	mm/inch	code
Hawa Concepta 25, set for 1 door	1250 – 1850 (4'1 $\frac{7}{16}$ " – 6'0 $\frac{27}{32}$ ")	27648
Hawa Concepta 30, set for 1 door	1851 – 2300 (6'0 $\frac{7}{8}$ " – 7'6 $\frac{9}{16}$ ")	27649

Sets comprising

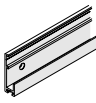
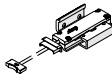
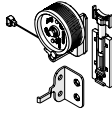
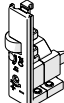
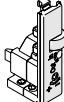
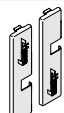
		27648	27649	code
	Upright, 1800 mm (5'10 $\frac{1}{8}$ "), alu plain anodized	1	–	22055
	Upright, 2300 mm (7'6 $\frac{9}{16}$ "), alu plain anodized	–	1	24699
	Scissor action, complete, 900 mm (2'11 $\frac{7}{16}$ "), galvanized steel	1	–	22592
	Scissor action, complete, 1500 mm (4'11 $\frac{1}{16}$ "), galvanized steel	–	1	22593
	Front scissor guide, alu plain anodized	1	1	25592
	Rear scissor guide, alu plain anodized	1	1	25596
	Rear scissor bearing, galvanized steel	1	1	25855
	Concealed hinge with soft closing mechanism, galvanized, 3 pieces	1	1	27654
	Spacer profil, 860 mm (2'9 $\frac{7}{8}$ "), plastic black, predrilled	1	1	22861
	Brush guide, set of 3 pieces, plastic, black	1	1	25815

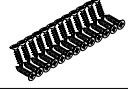
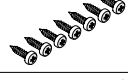
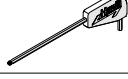
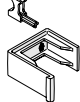







		27648	27649	code
	Upright guide, with zero clearance, with plastic rollers	2	2	25656
	Torsion plate	1	1	27704
	Bottom guide channel, alu plain anodized, 728 mm (2'4 $\frac{3}{8}$ "), predrilled	2	–	24533
	Bottom guide channel, alu plain anodized, 896 mm (2'11 $\frac{3}{8}$ "), predrilled	–	2	24535
	Stop damper with retaining bracket	1	–	24661
		–	1	24660
	Door pull-in 25/50 with end position soft closing system, plastic, black	1	–	25814
	Door pull-in 30/40 with end position soft closing system, plastic, black	–	1	25813
	Stop cover cap, depth ajustable, top left / bottom right	1	1	27657
	Stop cover cap, depth ajustable, top right / bottom left	1	1	27658
	Cover plates, stainless steel, 1 pair	1	1	24739
	Soft closing system for end position and cover caps for scissor guide	1	1	25862
	Set of screws for concealed hinges, 4 x 16 mm (3/8" x 5/8"), 10 pieces	1	1	25935
	Screw set for fitting hardware to cabinet body, 4,5 x 20 mm (3/16" x 25/32"), 20 pieces	1	1	22451
	Screw set for spacer profile, PH 4 x 16 mm (5/32" x 5/8"), 7 pieces	1	1	25562
	Hex key, 3 mm (1/8"), with handle	1	1	13164
	Installation aid, plastic, red	1	1	25816

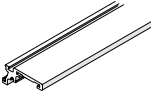





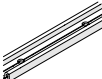







Subject to modification. Metric specifications are exact. Inches are approximate.

Sets, Hawa Concepta 40/50

	mm/inch	code
Hawa Concepta 40, set for 1 door	1851–2500 (6'0 ^{7/8"} –8'2 ^{1/16"})	27650
Hawa Concepta 50, set for 1 door	2301–2850 (7'6 ^{19/32"} –9'4 ^{7/32"})	27651

Sets comprising

		27650	27651	code
	Upright, 2500 mm (8'2 ^{7/16"}), alu plain anodized	1	–	22056
	Upright, 2760 mm (9'0 ^{21/32"}), alu plain anodized	–	1	22057
	Scissor action, complete, 1500 mm (4'11 ^{1/16"}), galvanized steel	1	1	22594
	Front scissor guide, alu plain anodized	1	1	25592
	Rear scissor guide, alu plain anodized	1	1	25596
	Rear scissor bearing, galvanized steel	1	1	25855
	Concealed hinge with soft closing mechanism, galvanized, 4 pieces	1	–	27655
	Concealed hinge with soft closing mechanism, galvanized, 5 pieces	–	1	27656
	Spacer profil, 860 mm (2'9 ^{7/8"}), plastic black, predrilled	1	1	22861
	Brush guide, set of 3 pieces, plastic, black	1	1	25815
	Two-wheeled trolley alu, with ball bearing wheels, height-adjustable, with torsion plate, dull nickel finish	1	1	24955

		27650	27651	code
	Upright guide, with zero clearance, with plastic rollers	1	1	25656
	Top track, 896 mm (2'11 ^{3/16"}), alu plain anodized, predrilled	1	1	24528
	Bottom guide channel, 896 mm (2'11 ^{3/16"}), alu plain anodized, predrilled	1	1	24535
	Stop damper with retaining bracket	1	1	24660
	Door pull-in 25/50 with end position soft closing system, plastic, black	–	1	25814
	Door pull-in 30/40 with end position soft closing system, plastic, black	1	–	25813
	Stop cover cap, depth adjustable, top left / bottom right	1	1	27657
	Stop cover cap, depth adjustable, top right / bottom left	1	1	27658
	Cover plates, stainless steel, 1 pair	1	1	24739
	Soft closing system for end position and cover caps for scissor guide	1	1	25862
	Set of screws for concealed hinges, 4 x 16 mm (5/8" x 5/8"), 10 pieces	1	1	25935
	Screw set for fitting hardware to cabinet body, 4,5 x 20 mm (3/16" x 25/32"), 20 pieces	1	1	22451
	Screw set for spacer profile, PH 4 x 16 mm (5/8" x 5/8"), 7 pieces	1	1	25562
	Hex key, 3 mm (1/8"), with handle	1	1	13164
	Installation aid, plastic, red	1	1	25816

Design option: Door striking against the top and bottom cabinet section

The implementation of cabinets using Hawa Concepta 25/30/40/50 makes cabinet construction simple. In conjunction with the optionally available connector profile, the Hawa Concepta 25/30/40/50 pivot/slide-in door hardware forms a modular overall system with extremely simple installation.

This makes it possible for single pivot/slide-in doors to be slid into a 55 mm niche or pairs of pivot/slide-in doors to be slid into a 110 mm niche. The Connector 55 and Connector 110 mm profiles can be used to connect the Hawa Concepta 25/30 with guide rollers for lightweight doors and also connect the Hawa Concepta 40/50 with a running gear for large and heavy doors.

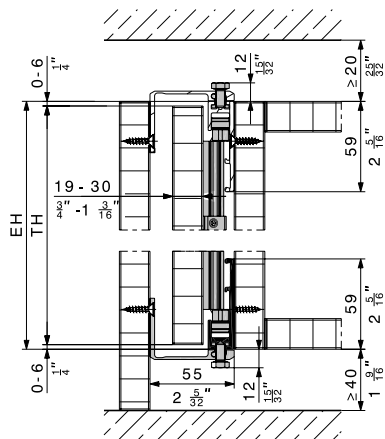
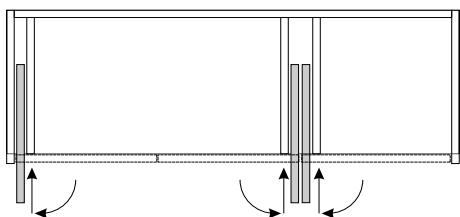
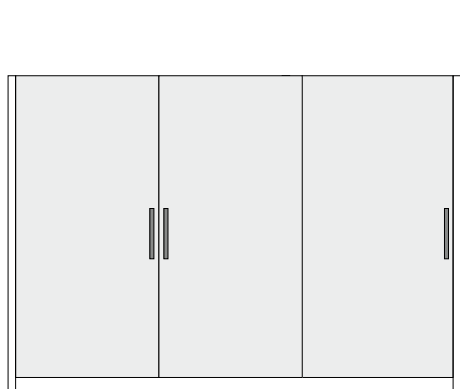

System: Hawa Concepta 25/30
Connection: Connector 55 mm (2 3/32")

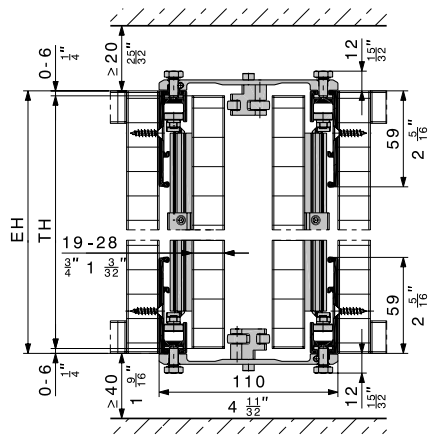

System: Hawa Concepta 25/30
Connection: Connector 110 mm (4 11/32")

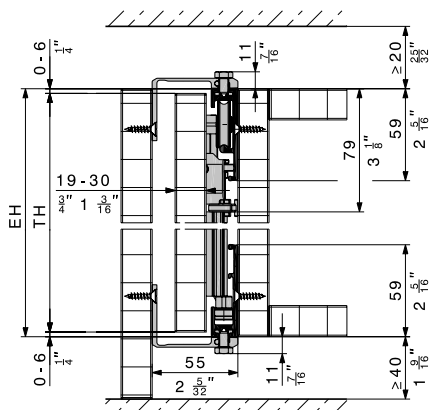

System: Hawa Concepta 40/50
Connection: Connector 55 mm (2 3/32")

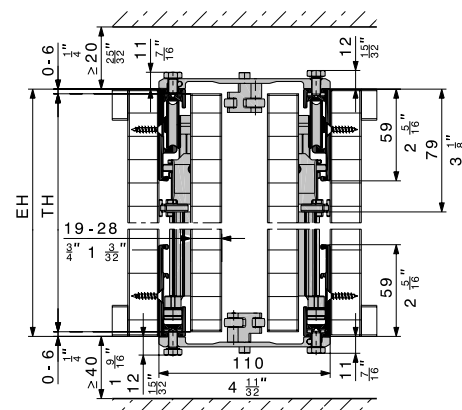

System: Hawa Concepta 40/50
Connection: Connector 110 mm (4 11/32")

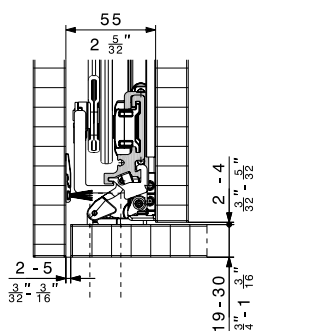

Connector 55 mm (2 3/32")
Maximum door thickness: 30 mm (1 1/8")

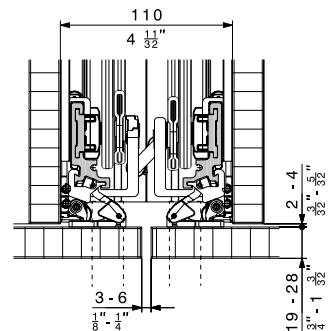

Connector 110 mm (4 11/32")
Maximum door thickness: 28 mm (1 1/16")

Subject to modification. Metric specifications are exact. Inches are approximate.

Connecting profile to the external side or cabinet body

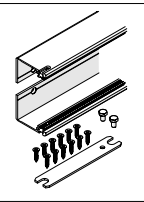
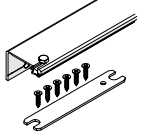
		mm/inch	code
	Connector 55 mm (2 ³ / ₁₆ ") for one pivot/slide-in door, alu plain anodized, 2 pieces	650 (2'1 ¹³ / ₃₂ ")	25438
	Connector 55 mm (2 ³ / ₁₆ ") for one pivot/slide-in door, alu plain anodized, 1 piece	650 (2'1 ¹³ / ₃₂ ")	23221
		900 (2'11 ⁷ / ₁₆ ")	23222

Connecting profile to the cabinet body

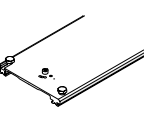
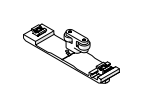
		mm/inch	code
	Connector 110 mm (4 ¹¹ / ₃₂ ") for two pivot/slide-in doors, alu plain anodized, 1 piece	650 (2'1 ¹³ / ₃₂ ")	23223
		900 (2'11 ⁷ / ₁₆ ")	23224
	Connector 110 mm (4 ¹¹ / ₃₂ ") for two pivot/slide-in doors, alu plain anodized, 1 piece (for installation in front of a fixed base)	26 (1 ¹ / ₃₂ ")	23225

Connector for Hawa Concepta 25/30/40/50

The Connector connection profile for the Hawa Concepta 25/30/40/50 is a well-thought-out method of simplifying the assembly of designs with pivot/slide-in doors striking against the top and bottom cabinet sections. Assembly is not only easy but also quick and convenient: the cabinet side or body sections are placed adjacent to one another; the Connector connection profile is then inserted in the top tracks and bottom guide channels and screwed tight from above – job done.

Features of Connector 55 mm (2 ³/₁₆")

- For recesses with a pivot/slide-in door made of wood: 19–30 mm (³/₄" – 1 ³/₁₆")
- The Connector compensates external side or cabinet body height differences of up to ± 1.5 mm (1 ¹/₁₆")

Typisch Connector 110 mm (4 ¹¹/₃₂")

- For recesses with two pivot/slide-in doors made of wood: 19–28 mm (³/₄" – 1 ¹/₈")
- The Connector compensates cabinet body height differences of up to ± 1.5 mm (1 ¹/₁₆")

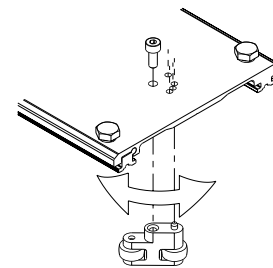

Connector 55 mm (2 ³/₁₆")

Connector 110 mm (4 ¹¹/₃₂")

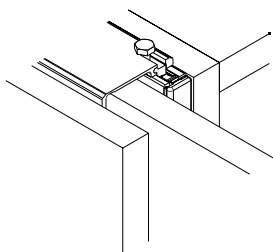

Connector 55 mm (2 ³/₁₆"):
recess for one pivot/slide-in door

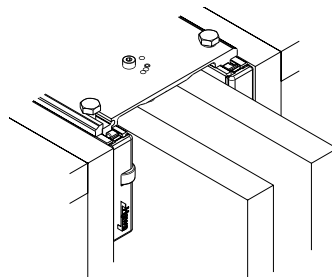

Connector 110 mm (4 ¹¹/₃₂"):
recess for two pivot/slide-in doors

Kitchen designs with and without a fixed base

The Connector for the Hawa Concepta 25/30/40/50 is suitable for various kitchen designs. The same connector profile can be used for the top and bottom on designs with adjustable feet. A short 26 mm (1 ¹/₃₂") profile is available for designs with a fixed base.

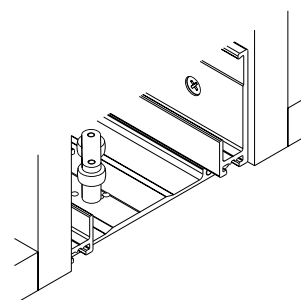

Design with adjustable feet
Top/bottom profile: No. 23223/23224

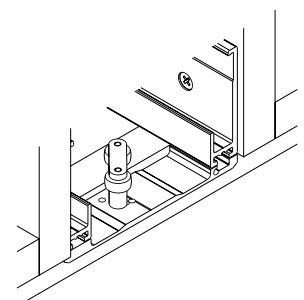

Design with a fixed base
Top profile: No. 23223/23224
Bottom profile: No. 23225

Hawa Concepta 25/30/40/50: Further design options

The Hawa Concepta 25/30/40/50 is suitable not only for sliding doors that strike against the cabinet into the cabinet body but also for inlaying doors made. Both variants can be installed in a wall recess without a cabinet body.

Inlaying doors

Hawa Concepta 25/30/40/50 can also be used to design inlaying fronts.

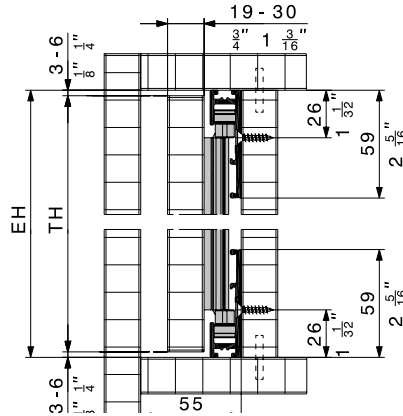
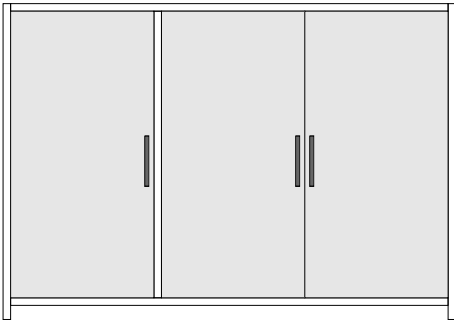

Hawa Concepta 25/30

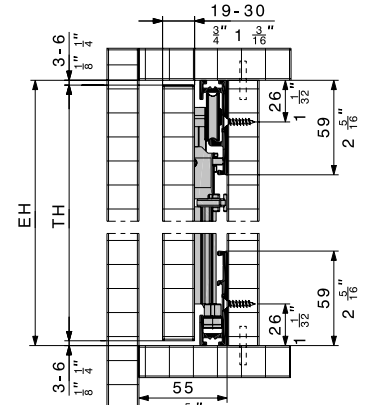

Hawa Concepta 40/50

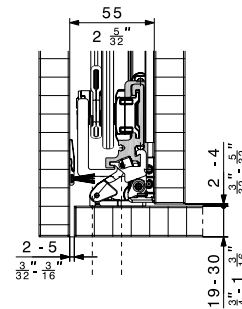
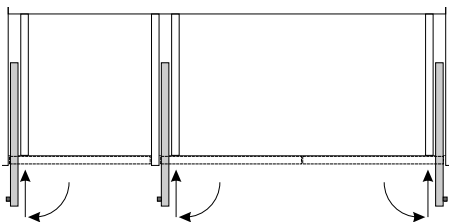

Hawa Concepta 25/30/40/50

Guide for two inlaid doors

The optional guide also allows two doors to be pushed into one pocket, also with inset structures.

Guide

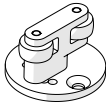
	code
Guide for two pivot /slide-in doors, aluminium, plain anodized	25680

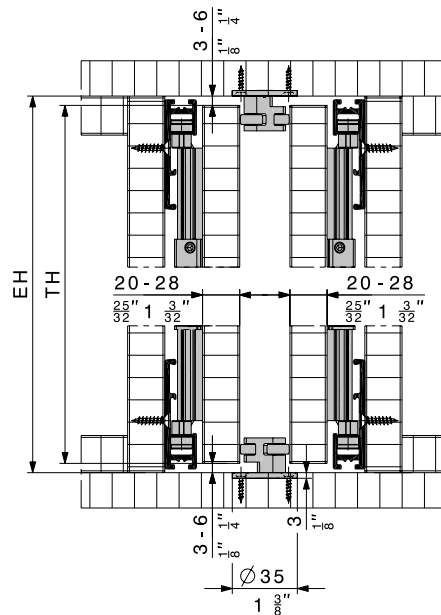
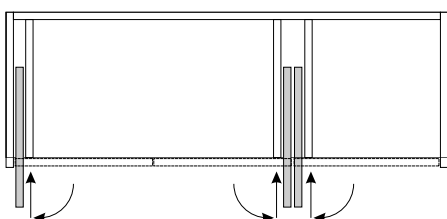

Subject to modification. Metric specifications are exact. Inches are approximate.

Door in wall recess

The Hawa Concepta 25/30/40/50 can also conceal wall recesses without a cabinet body.

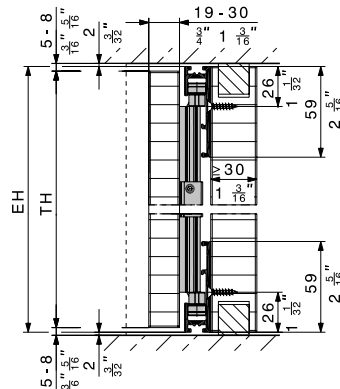
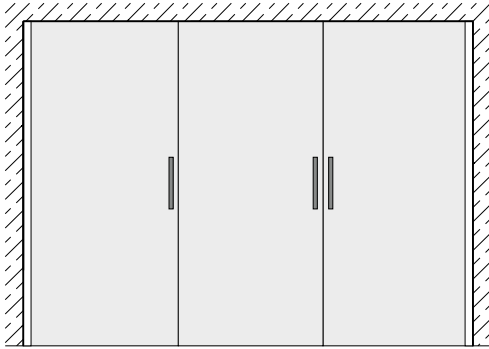

Hawa Concepta 25/30

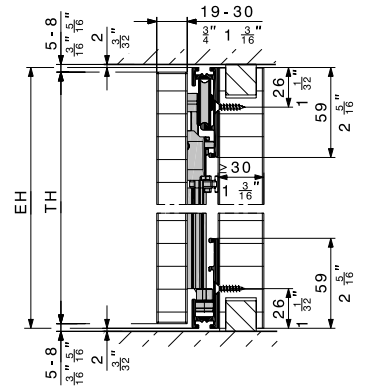

Hawa Concepta 40/50

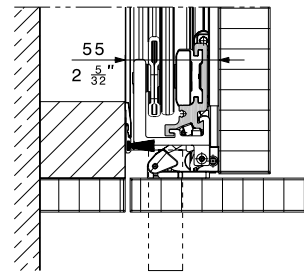
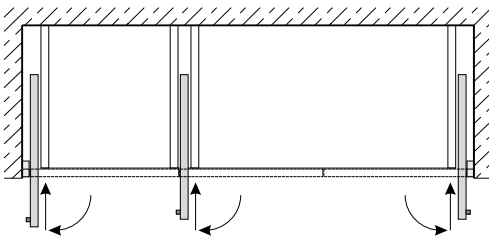

Hawa Concepta 25/30/40/50

Design variant: room partitioning solutions

Room-high designs for partitioning solutions are possible as the Hawa Concepta 25/30/40/50 does not require top and bottom cabinet sections. All components are screwed onto the intermediate panel.

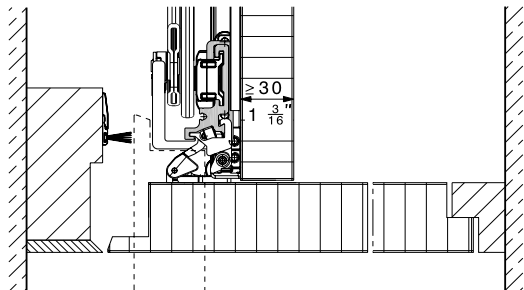

Hawa Concepta 40/50

Wood doors from 30 mm (1 3/16")

Rabbets enable the installation of wood doors with thicknesses starting from > 30–50 mm (1 3/16"–1 31/32")

Rabbet dimensions

S	N1	N2	N3	N4
19–30 mm (3/4"–1 3/16")	55 mm (2 3/16")	0 mm	0 mm	0 mm
33 mm (1 5/16")	58 mm (2 3/32")	0 mm	3 mm (1/8")	3 mm (1/8")
36 mm (1 7/16")	63 mm (2 1/2")	2 mm (3/32")	6 mm (1/4")	5 mm (7/32")
39 mm (1 17/32")	67 mm (2 21/32")	3 mm (1/8")	9 mm (3/8")	8 mm (5/16")
42 mm (1 21/32")	70 mm (2 3/4")	3 mm (1/8")	12 mm (15/32")	11 mm (7/16")
45 mm (1 25/32")	75 mm (2 15/16")	5 mm (7/32")	15 mm (19/32")	14 mm (9/16")
48 mm (1 29/32")	79 mm (3 1/8")	6 mm (1/4")	18 mm (23/32")	17 mm (11/16")
50 mm (1 31/32")	83 mm (3 9/32")	7 mm (9/32")	21 mm (27/32")	19 mm (3/4")

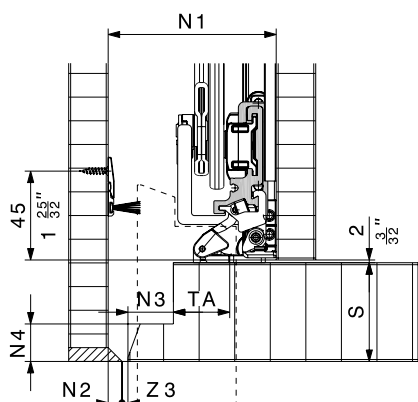

Shock absorber: high operational convenience

The shock absorber stops the door gently and quietly when it is pulled out.

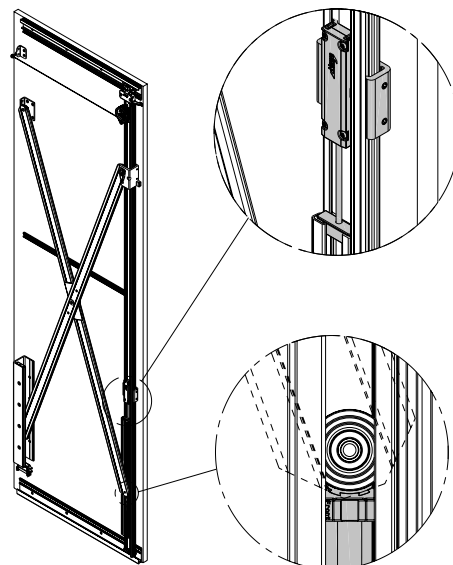

Stop cover caps and depth adjustment

The stop cover caps are screwed onto the face side of the top tracks and fulfill the following functions:

- The integrated guide roller makes it easy to pivot the door and slide it in, positioning it in the closed position
- The closed front can be aligned by 0–2 mm (0"–3/32") in the depth of the cabinet
- The hardware set includes a pair of stainless steel cover caps for extra visual appeal. They simply clip on to the stop cover caps

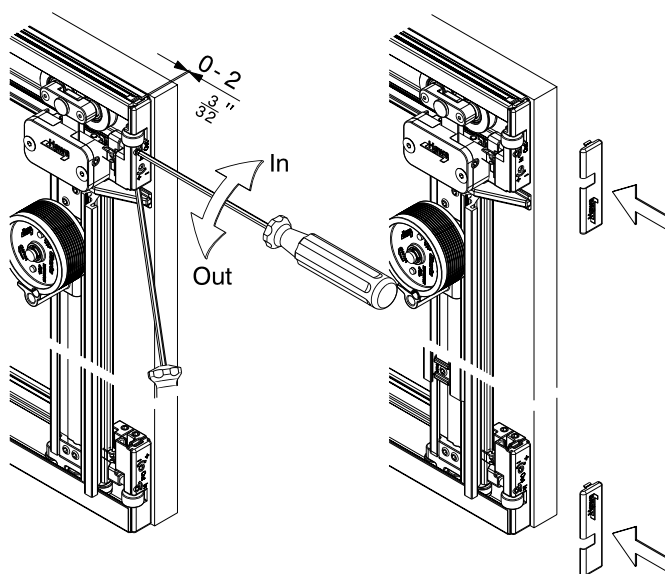

Front depth fine adjustment

Adjustment screw cover

Subject to modification. Metric specifications are exact. Inches are approximate.

Door handles

		mm/inch	code
	Door handle, alu plain anodized	400 (1'3 3/8")	22692
Please pay attention to the collision hazard when planning door handles in connection with the Connector.			

Door handle height

The height of the door handle should be determined accordingly if two cabinet elements are designed so that the door opening of one cabinet meets with the insert of the adjacent cabinet. We recommend shell handles or flush pull handles to building owners.

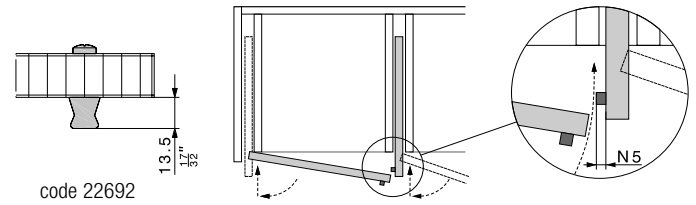

Door handle	S	N5
Hawa code 22692	19 mm (3/4")	13.5 mm (1/2")
Provided by customer	≤ 22 mm (7/8")	10 mm (3/8")
	≤ 25 mm (1 1/8")	5 mm (7/32")
	≤ 50 mm (1 31/32")	2 mm (3/32")
S = Door thickness N5 = Maximum door handle height for adjacent cabinets		

Aligner

The alignment hardware makes it easy to stabilise and adjust the pivot/slide-in doors. At least two hardware sets are recommended for each door and can be shortened as required.

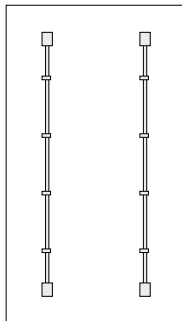

Order specifications

- Type and quantity of sets

Optional order specifications

- Quantity of connecting brackets for external or cabinet body connections
- Quantity of door handles
- Quantity of aligner

Planning/installation

For planning and installation purposes, please use the installation drawings:

- Hawa Concepta 25/30 code 30182
 - Hawa Concepta 40/50 code 30183
 - Connector for Hawa Concepta 25/30/40/50 code 23227
- (→ www.hawa.ch → Hawa Productfinder)

Subject to modification. Metric specifications are exact. Inches are approximate.